

SPECIFICATIONS		
SHELL WEIGHT PESO DE LA PISCINA	815,7 LBS.	370,0 Kg
FINISHES SURFACE SUPERFICIE DEL ACABADO	56,8 Ft ²	5,3 m ²
FINISHES WEIGHT (1"x1") PESO DEL ACABADO (2,5x2,5cm)	149,6 LBS.	67,8 Kg
WATER WEIGHT PESO DEL AGUA	65036,3 LBS.	29500,0 Kg
TOTAL WEIGHT PESO TOTAL	66001,6 LBS.	29937,8 Kg
WATER VOLUME VOLUMEN DE AGUA	1041,8 Cu.Ft.	29,5 m ³
WATER GALLONS AND LITERS GALONES Y LITROS DE AGUA	7793,1 GAL.	29500,0 L
SURFACE AREA ÁREA DE SUPERFICIE	344,0 Sq. Ft.	32,0 m ²
ICC-ES LISTED# ICC-ES LISTADO	ESR-4370	

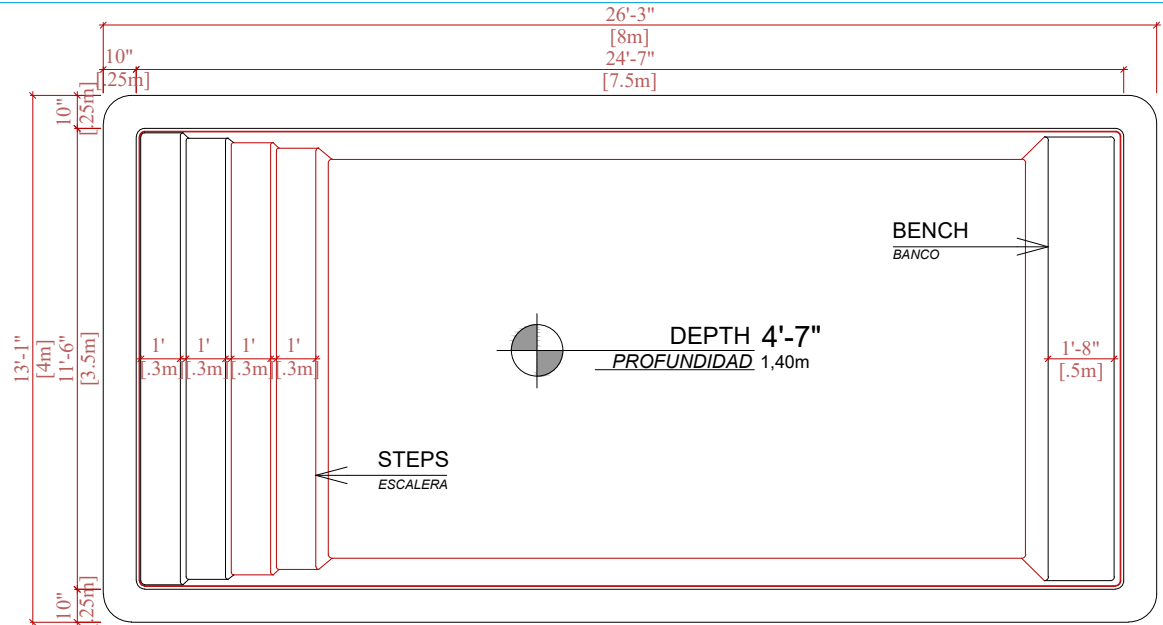

TECHNICAL DRAWING
DIBUJO TÉCNICO

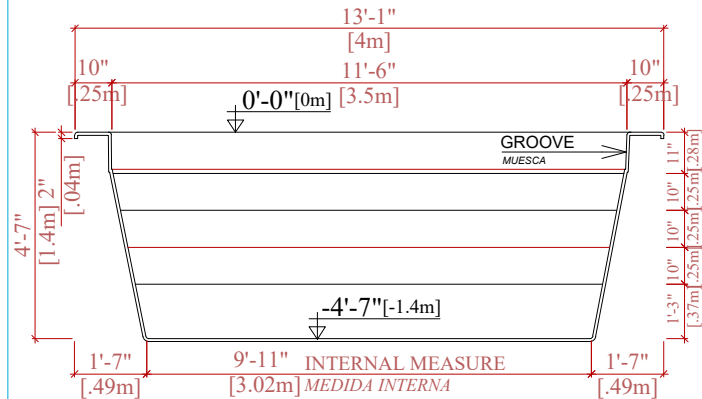

CROSS SECTION
CORTE TRANSVERSAL

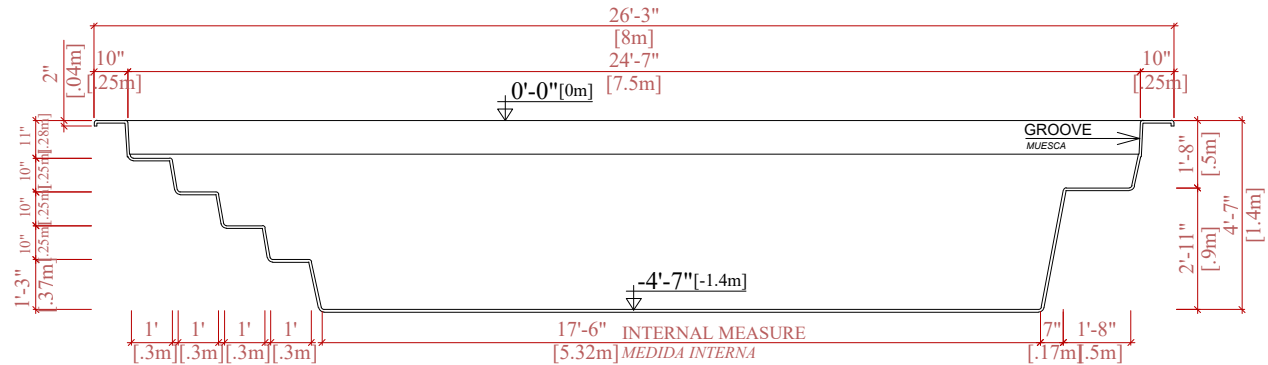

LONGITUDINAL SECTION
CORTE LONGITUDINAL